



**PANCAKE AND HOT DOG  
AIR COMPRESSORS  
MODEL H3370/H3371  
INSTRUCTION MANUAL**



COPYRIGHT © APRIL, 2003 BY GRIZZLY INDUSTRIAL, INC.  
**WARNING: NO PORTION OF THIS MANUAL MAY BE REPRODUCED IN ANY SHAPE  
OR FORM WITHOUT THE WRITTEN APPROVAL OF GRIZZLY INDUSTRIAL, INC.**  
PRINTED IN CHINA

**ONLINE MANUAL DISCLAIMER**

THE INFORMATION IN THIS MANUAL REPRESENTS THE CONFIGURATION OF THE MACHINE AS IT IS CURRENTLY BEING SHIPPED. THE MACHINE CONFIGURATION CAN CHANGE AS PRODUCT IMPROVEMENTS ARE INCORPORATED. IF YOU OWN AN EARLIER VERSION OF THE MACHINE, THIS MANUAL MAY NOT EXACTLY DEPICT YOUR MACHINE. CONTACT CUSTOMER SERVICE IF YOU HAVE ANY QUESTIONS ABOUT DIFFERENCES. PREVIOUS VERSIONS ARE NOT AVAILABLE ONLINE.

# WARNING

Some dust created by power sanding, sawing, grinding, drilling, and other construction activities contains chemicals known to the State of California to cause cancer, birth defects or other reproductive harm. Some examples of these chemicals are:

- Lead from lead-based paints.
- Crystalline silica from bricks, cement, and other masonry products.
- Arsenic and chromium from chemically treated lumber.

Your risk from these exposures varies, depending on how often you do this type of work. To reduce your exposure to these chemicals: work in a well ventilated area, and work with approved safety equipment, such as those dust masks that are specially designed to filter out microscopic particles.

# SAFETY

## **WARNING**

### **For Your Own Safety Read Instruction Manual Before Operating This Equipment**

The purpose of safety symbols is to attract your attention to possible hazardous conditions. This manual uses a series of symbols and signal words which are intended to convey the level of importance of the safety messages. The progression of symbols is described below. Remember that safety messages by themselves do not eliminate danger and are not a substitute for proper accident prevention measures.

 **DANGER** Indicates an imminently hazardous situation which, if not avoided, WILL result in death or serious injury.

 **WARNING** Indicates a potentially hazardous situation which, if not avoided, COULD result in death or serious injury.

 **CAUTION** Indicates a potentially hazardous situation which, if not avoided, MAY result in minor or moderate injury. It may also be used to alert against unsafe practices.

**NOTICE** This symbol is used to alert the user to useful information about proper operation of the equipment.

## **WARNING**

### **Safety Instructions For Pneumatic Tools**

- KEEP ALL SAFETY DEVICES IN PLACE** and in working order.
- REMOVE ADJUSTING KEYS AND WRENCHES.** Form a habit of checking to see that keys and adjusting wrenches are removed from tool before operation.
- KEEP WORK AREA CLEAN.** Cluttered areas and benches invite accidents.
- DO NOT USE IN DANGEROUS ENVIRONMENT.** DO NOT use pneumatic tools in damp or wet locations, or where any flammable or noxious fumes may exist. Keep work area well lighted.
- KEEP CHILDREN AND VISITORS AWAY.** All children and visitors should be kept at a safe distance from work area.
- MAKE WORKSHOP CHILD PROOF** with padlocks, master switches, or by removing air hoses from tools.
- DO NOT FORCE TOOL.** It will do the job better and safer at the rate for which it was designed.
- USE THE RIGHT TOOL.** DO NOT force tool or attachment to do a job for which it was not designed.
- DO NOT USE UNDER THE INFLUENCE OF DRUGS OR ALCOHOL.**

# WARNING

## Safety Instructions For Pneumatic Tools

10. **USE PROPER AIR HOSE** for the tool. Make sure your air hose is in good condition and is long enough to reach your work without stretching.
11. **WEAR PROPER APPAREL.** DO NOT wear loose clothing, gloves, neckties, rings, bracelets, or other jewelry which may get caught in moving parts. Non-slip footwear is recommended. Wear a protective hair covering to contain long hair.
12. **ALWAYS USE SAFETY GLASSES.** Also use a face or dust mask if cutting operation is dusty. Everyday eyeglasses only have impact resistant lenses, they are NOT safety glasses.
13. **WEAR APPROVED HEARING PROTECTION.**
14. **NEVER USE PLASTIC (PVC) PIPE FOR COMPRESSED AIR.** Serious injury could result.
16. **MAINTAIN TOOLS WITH CARE.** Keep tools lubricated and clean for best and safest performance. Follow instructions for lubricating and changing accessories.
17. **REDUCE THE RISK OF UNINTENTIONAL STARTING.** DO NOT carry tool with hand on trigger and always disconnect from air when not in use.
18. **DISCONNECT TOOLS** before servicing and changing accessories.
19. **USE THE RECOMMENDED ACCESSORIES.** Consult the owner's manual for recommended accessories. The use of improper accessories may cause risk of injury.
20. **CHECK DAMAGED PARTS.** Before further use of the tool, a guard or other part that is damaged should be carefully checked to determine that it will operate properly and perform its intended function. Check for alignment of moving parts, binding of moving parts, breakage of parts, mounting, and any other conditions that may affect its operation. A guard or other part that is damaged should be properly repaired or replaced.
21. **NEVER LEAVE UNATTENDED TOOL CONNECTED TO AIR.** Disconnect the air hose and DO NOT leave tool until it is relieved of any built up pressure.
22. **NEVER ALLOW UNTRAINED USERS TO USE THIS TOOL WHILE UNSUPERVISED.**
23. **IF YOU ARE UNSURE OF THE INTENDED OPERATION, STOP USING THE TOOL.** Seek formal training or research books or magazines that specialize in pneumatic tools.

## **!WARNING**

### **Additional Safety For Air Compressors**

1. **READ THIS ENTIRE MANUAL BEFORE OPERATING THE COMPRESSOR.**
2. **OPERATE THE COMPRESSOR IN A WELL VENTILATED AREA** free of acids, vapor, explosive gases and flammable or unstable materials.
3. **DO NOT PULL ON THE GAUGES OR REGULATORS TO MOVE THE COMPRESSOR!**
4. **DO NOT USE THE COMPRESSOR FOR FILLING BREATHING OR DIVING APPARATUS.** Compressed air from this compressor cannot be used for pharmaceutical, food or health requirements without further treatment.
5. **NEVER TRANSPORT THE COMPRESSOR UNDER PRESSURE.** Always release the pressure in the storage tanks before moving.
6. **NEVER RUN THE COMPRESSOR BEYOND THE ADVISED DUTY CYCLE!**
7. **DRAIN TANK DAILY OR AT THE END OF EACH USE** to avoid tank corrosion and possible tank rupture.
8. **AVOID TOUCHING THE TOP OF THE MOTOR HOUSING,** it will become hot during operation.
9. **MAKE SURE TO ADD OIL!** Use compressor oil or a non-detergent 30 weight oil.
10. **NEVER LEAVE COMPRESSOR TURNED ON WHEN NO ONE IS AROUND!** A leak could develop causing compressor to run continuously causing overheating and possibly a fire.
11. **NEVER AIM THE AIR NOZZLE DIRECTLY AT YOURSELF OR OTHERS.** Pressurized air can break or bruise the skin.
12. **NEVER LOAD YOUR COMPRESSOR PAST THE MAXIMUM PSI RATING!**

### **NOTICE**

Always be aware of the duty cycle for your air compressor. Failure to operate the air compressor properly could result in overheating and motor seizure. There could also be risk of fire hazard due to overheating. Be sure to use a compressor capable of handling the air demand of connected tools

### **!WARNING**



Operating this compressor can propel objects into the air, causing immediate eye damage. To protect yourself, always wear American National Standards Institute (ANSI) approved safety glasses or goggles when operating this equipment.

# INTRODUCTION AND SET UP

## Commentary

We are proud to offer the Grizzly Model H3370 Pancake and H3371 Hot Dog Air Compressors. These models are part of a growing Grizzly family of fine power tools. When used according to the guidelines set forth in this manual, you can expect years of trouble-free, enjoyable operation and proof of Grizzly's commitment to customer satisfaction.

The Model H3370 features a 2.5 HP motor, a cast iron direct drive pump, 4 gallon tank capacity that delivers 4.6 CFM @90 PSI and 5.9 CFM @40 PSI, and is oil lubricated. The H3370 has a maximum PSI rating of 115.

The Model H3371 features a 2.5 HP motor, a cast iron direct drive pump, two 2 gallon tanks that deliver 4.6 CFM @90 PSI and 5.9 CFM @40 PSI, and is oil lubricated. The H3371 has a maximum 115 PSI rating.

We are pleased to provide this manual with the Model H3370 and H3371. It was written to encourage safety considerations and guide you through general operating procedures and maintenance. This manual represents our effort to produce the best documentation possible.

The specifications, details, and photographs in this manual represent the Model H3370/H3371 as supplied when the manual was prepared. However, owing to Grizzly's policy of continuous improvement, changes may be made at any time with no obligation on the part of Grizzly.

If you have any comments regarding this manual, please write to us at the following address:

Grizzly Industrial, Inc.  
c/o Technical Documentation  
P.O. Box 2069 Bellingham, WA 98227-2069

Most important, we stand behind our tools. If you have any service questions or parts requests, please call or write us at the location listed below.

Grizzly Industrial, Inc.  
1203 Lycoming Mall Circle  
Muncy, PA 17756  
Phone: (570) 546-9663  
Fax: (800) 438-5901  
E-Mail: [techsupport@grizzly.com](mailto:techsupport@grizzly.com)  
Web Site: <http://www.grizzly.com>

**!WARNING**

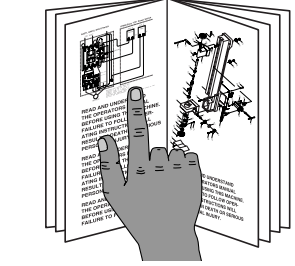

**Read the manual before assembly and operation. Become familiar with this machine, its safety instructions, and its operation before beginning any work. Serious personal injury may result if safety or operational information is not understood or followed.**

## Unpacking

This air compressor is shipped from the manufacturer in a carefully packed carton. If you discover the machine is damaged after you have signed for delivery, and the truck and driver are gone, you will need to file a freight claim with the carrier. Save the containers and all packing materials for possible inspection by the carrier or its agent. Without the packing materials, filing a freight claim can be difficult. *If you need assistance determining whether you need to file a freight claim, or with the procedure to file one, please contact our Customer Service at (570) 546-9663.*

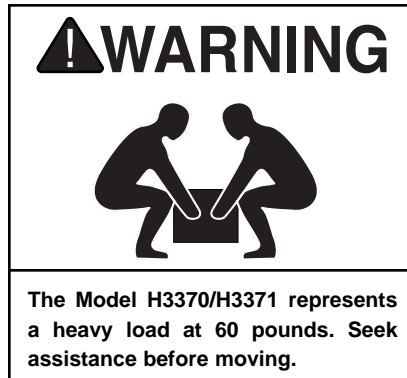

## Site Placement

When determining where to set up the air compressor in the shop or when taking the air compressor to a job site, the most important consideration is access to an adequate and properly fused power supply. Refer to *Circuit Requirements* for the needs of your particular compressor.

Also, make sure the compressor is not operating in an environment where there are any explosive, flammable or caustic fumes or gases. A clear and well ventilated area is best for its safe operation.

Place the compressor on a solid and level surface. Make sure that the hoses you attach to your pneumatic device will be unrestricted in movement and not subject to being run over by vehicles or punctured by any sharp objects in the area.

Since air compressors are often used for a sustained period of time, sometimes in restricted areas, it is also best to wear ear protection to avoid long term exposure to the sound of the electric motor and piston.

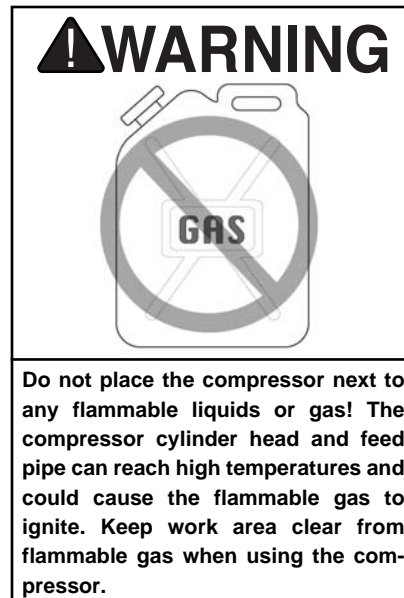

# CIRCUIT REQUIREMENTS

## 110V Operation

The Model H3370/H3371 Air Compressor is wired for 110/120V, single-phase operation only. The maximum amperage draw for the machine is 17 amps, with a fusing level rating of 20 amps.

It is best to operate a compressor on a dedicated circuit, i.e. a circuit where there are no other electrical appliances plugged in. The fuse requirements above assume the use of a circuit breaker or a slow-blow fuse. If an unusual load does not exist and the compressor still breaks the circuit, contact a qualified electrician or our service department at (570) 546-9663.

## Extension Cords

If you find it necessary to use an extension cord with your compressor, make sure the cord is rated Standard Service (grade S) or better. Refer to the chart in the standard safety instructions to determine the minimum gauge for the extension cord. The extension cord must also contain a ground wire and plug pin. Always repair or replace extension cords when they become worn or damaged.

### **⚠️ WARNING**

Overheating, short circuit and fire damage will result from inadequate wiring. Follow the guidelines in this section.

## Grounding

In the event of an electrical short, grounding reduces the risk of electric shock by providing a path of least resistance to disperse electric current. These machines are equipped with power cords having an equipment-grounding conductor. See **Figure 1**. The outlet must be properly installed and grounded in accordance with all local codes and ordinances.

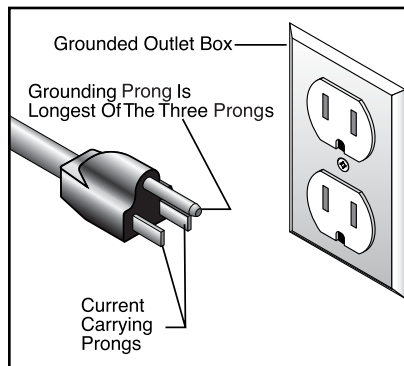

**Figure 1.** Ground plug configuration.

### **⚠️ WARNING**



Potential for electrical shock hazard, this equipment must be grounded. Verify that any existing electrical outlet and circuit you use is actually grounded.



# PREPARING FOR USE

Before using your Grizzly Air Compressor, follow these steps:

1. Remove all packing materials and any protective plastic bags, zip tie labels or tags from the compressor.
2. Be sure the air filter is attached to the cylinder head as shown in **Figure 2**.

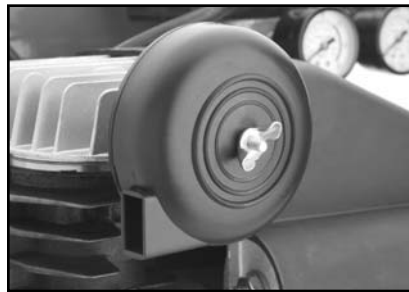

**Figure 2.** Air filter attached to cylinder head.

3. **ADD OIL TO THE CRANKCASE.** Oil has been supplied with your air compressor. Remove the oil breather on top of the crankcase and add oil into the hole. The oil level should be in the center of the sight gauge shown in **Figure 3**.

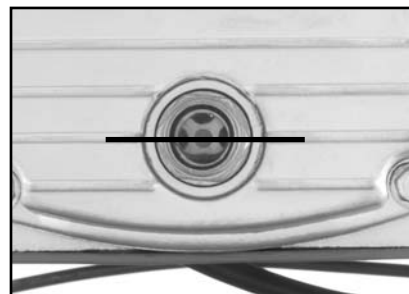

**Figure 3.** Proper oil level.

4. Make sure the drain valve on the air tank is closed.

## NOTICE

The machine should never be run without a full oil reservoir. The oil provides lubrication to the cylinder rings which deliver the compressed air. Severe damage to the internal moving parts can occur if there is not adequate oil flow. Check the oil level frequently, and change the oil every 3 months.

5. Know and understand the duty cycle of the compressor before operating.

## Duty Cycle

The Model H3370/H3371 Air Compressor should *NOT* be operated on more than a 50% duty cycle. (This means an air compressor that pumps air for over 30 minutes in one hour is considered misuse. This could mean that the air compressor is undersized for the required air demand. Note—*The maximum compressor pump time per hour is 30 minutes.*

## ! WARNING

Overheating, short circuit and fire damage will result from operating beyond the recommended duty cycle. Severe injury and property damage could occur.

# STARTING

## To start the air compressor:

1. Make sure the compressor switch is in the **OFF** position (lever with red cap above pressure gauges shown in **Figure 4**) before connecting to the power supply.

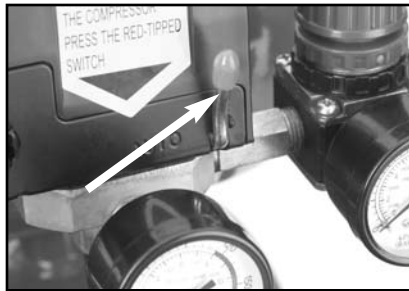

Figure 4. ON/OFF lever.

2. Close the drain valve, shown in **Figure 5**, so the tank can build up pressure.



Figure 5. Drain valve location.

3. Double check the oil level to make sure it is at the proper height.
4. Connect the compressor to the power supply.
5. Flip the switch to the ON position (where it reads **AUTO**).

Check the pressure gauge to see that the tank pressure climbs to approximately 100-115 PSI or around 8 BAR, then automatically turns off.

*Note—If the compressor does not automatically kick off, flip the ON/OFF switch to OFF before pressure gets too high. See the Pressure Regulator section.*

## **!WARNING**

Operating this equipment has the potential for flying debris to cause eye injury. Always wear safety glasses or goggles when operating equipment. Everyday glasses or reading glasses only have impact resistant lenses, they are not safety glasses. Be certain the safety glasses you wear meet the appropriate standards of the American National Standards Institute (ANSI).

# AIR CONTROL

## Delivered Pressure

The tank pressure is displayed on the left pressure gauge, and the air to be delivered to the tool is displayed on the right pressure gauge shown in **Figure 6**.



**Figure 6.** Pressure gauges.

**To control the air delivery to your tool:**

1. Adjust the air control knob, shown in **Figure 7**, to set the PSI that will be delivered to your tool. Turn the knob clockwise to increase the pressure and counter-clockwise to decrease the pressure.

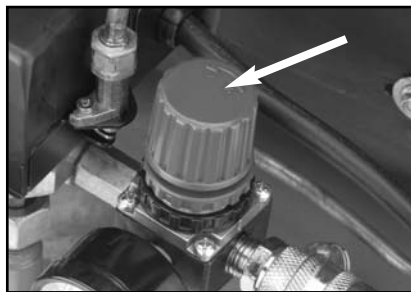

**Figure 7.** Air control knob.

**Note**—*The air tool that you attach to the air compressor should have a preferred PSI operating level. Set the pressure to be delivered to the tool according to the tool's preferred level. Understand the duty cycle of the air compressor.*

## Air Release

There are two ways to release air from the compressor tank other than through your regulator and the use of air tools:

- The drain valve
- The safety drain valve

To release air by using the drain valve, you simply turn the release nut to allow air to flow out of the tank. The drain valve is shown in **Figure 5**. The drain valve is also used to drain condensation that builds up in the tank.

The safety valve automatically releases pressure if the tank reaches 130 PSI.

**To manually release the air in the tank by using the safety drain valve:**

1. Locate the safety drain valve on the tank. The drain valve is shown below in **Figure 8**.



**Figure 8.** Safety drain valve.

2. Pull the metal ring on top of the safety valve to bleed pressure from the tank. **Note**—*The ring is preset to release air if the tank exceeds its maximum pressure. DO NOT try to adjust the safety valve's pressure setting!*

## Tank Pressure Regulator

The pressure regulator has been factory set for the highest quality operating performance.

The pressure regulator sets the turn off PSI setting for the air compressor tank.

### **NOTICE**

**The Model H3370/H3371 Air Compressors have been factory set to kick off at the proper PSI range. Only attempt to adjust the pressure regulator if your air compressor does not reach or pressurizes beyond the proper PSI level.**

To adjust the pressure regulator:

1. **Unplug the air compressor from the power supply.**
2. Make sure the compressor switch is in the *OFF* position.
3. Drain the pressure from the tank.
4. Remove the black *ON/OFF* switch cover by removing the screw which is in the recess on the top of the cover. Pull the black cover up and set it aside.
5. Turn the pressure adjustment screw (**Figure 9**) a half turn clockwise to increase the tank pressure and a half turn counter-clockwise to decrease the pressure.
6. Connect the compressor to the power supply and start compressor.
7. If the PSI level still needs adjustment, repeat **steps 1 through 6**.
8. Replace the cover when the proper adjustments have been made.

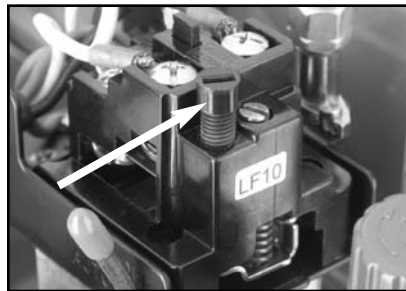

**Figure 9.** Pressure Regulator

# CONNECTING TOOLS

## To connect air tools to your air compressor:

1. Make sure the compressor model you use has a sufficient cubic feet per minute (CFM) output for the air tool you plan to connect. (Most air tools will have an air requirement stated in terms of a specific CFM at a specific pressure.)
2. The compressor should put out a higher CFM than the tool requires.

If you are connecting multiple tools that will be used simultaneously, then the CFM for each tool should be added together and compared to the compressor output value.

3. Connect the tool, using a good quality air line with an adequate length to reach from the compressor to the point of use.

Note—Quick-connect couplers, shown in Figure 10, are a good option for fast and sure connection of tools and air hoses.

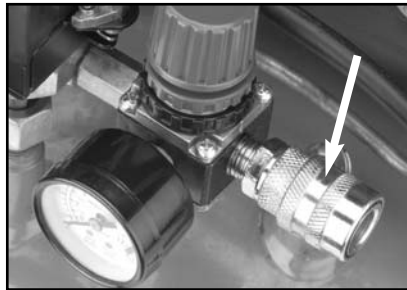

Figure 10. Quick connect couplers

These couplers are included with the air compressor. Make certain the air hose will not be placed in a position where it can become constricted or cut by a sharp object. Note—Running over a hose with heavy vehicles may not cause an immediate leak, but it will shorten the life of the hose.

Model H3370/H3371 Air Compressors

Consideration should also be given to the type of usage. A nailer or staple gun uses air in short bursts and it is easier for the compressor to maintain pressure. A paint sprayer or grinder tends to use a more continuous stream of air as these tools are run for longer time periods. It is always better to oversize a compressor to allow for variation in the type of usage and the number of tools to be powered. Air tools being operated with insufficient air volume will not perform their function satisfactorily.

**! WARNING**

Always disconnect air hose from tools whenever not in use or while servicing! During maintenance, a tool connected to air may operate accidentally, causing serious personal injury!

**! WARNING**

The Model H3370/H3371 Air Compressors are specifically designed for air tool operation. **DO NOT MODIFY OR USE THIS MACHINE FOR ANY OTHER PURPOSE.** Modifications or improper use of this tool will void the warranty. If you are confused about any aspect of this machine, **DO NOT** use it until you have answered all your questions. Serious personal injury may occur.

# MAINTENANCE

## Each Use

Regular periodic maintenance on your air compressor will ensure its optimum performance. Make a habit of inspecting your compressor each time you use it. Check the following items:

1. **Check Oil Level!** Use the sight gauge on the bottom of the crankcase to make sure the oil level is at the proper height.
2. Drain tanks daily of any condensation by opening the drain valve on the bottom of the tank and leave open until the next time it is used.

Depending upon the amount of use and the surrounding humidity, a certain amount of condensed water may accumulate in the tanks. For longevity of the compressor seals and the air tools you connect, it is best to drain water from the tanks. The tanks are best drained if the drain valve is open when the system is pressurized.

### **WARNING**

Always wear safety glasses and use extreme caution when working around compressed air. The force of the air stream can cause small bits of debris to become airborne and cause potential injury to the eyes or other parts of the body. Never let the full force of the air stream come in direct contact with the skin as it can cause abrasions or bruising, penetration of skin and could even lead to death!

### **WARNING**

The air compressor will cycle automatically when it is on. When performing any type of maintenance always make sure the AUTO/OFF lever is in the OFF position the unit is unplugged and bleed out all tank pressure.

3. Clean off the cylinder head cooling fins. Dirt interferes with heat transfer.
4. Check for worn or damaged cords and plugs.
5. Check for any other condition that could hamper the safe operation of this machine.
6. Check the safety drain valve to make sure it is working properly.

### **WARNING**

Always drain the air from the tank before performing any maintenance or transporting your air compressor. Damage to the air compressor while under pressure could cause bursting or explosion and injury or property damage could occur.

## After First 50 Hours of Use

---

After the first 50 working hours or 30 days, whichever comes first, the following maintenance should be done.

1. Replace the oil in the motor with compressor oil or use ISO 100 or SAE 30W viscosity, non detergent type oil.
2. Check to make sure that all the fittings are tight.
3. Remove the air filter foam element shown in **Figure 11** and rinse it out with water. Allow it to dry and re-install.



**Figure 11.** Air filter foam element

4. Blow out any dirt that has accumulated between the cylinder cooling fans.

## Weekly

---

If the compressor is used on a daily basis, perform the following checks each week.

1. Rinse the air filter foam element in water.
2. Check for loose bolts or fittings.
3. Clean off all foreign material from cylinder head, motor, fan, air lines, exhaust pipe, couplers and frame.
4. Check air lines and connectors to make sure they are in good condition.

## Every 300 Hours

---

After every 300 hours or 3 months of regular operation, perform the following maintenance items:

1. Change the compressor motor oil.
2. Rinse the air filter foam element in water.
3. Check for air leaks and correct as needed.
4. Clean the cylinder head fins for proper cooling.
5. Check for loose bolts or fittings.

### **WARNING**

Like all power tools, there is danger associated with operating this equipment. Accidents are frequently caused by lack of familiarity or failure to pay attention. Use this machine with respect and caution to lessen the possibility of operator injury. If normal safety precautions are overlooked or ignored, serious personal injury may occur.

## Storage

---

When storing your air compressor, follow these guidelines:

1. Set the compressor switch lever to *OFF*.
2. Turn the regulator counter-clockwise to set the delivery pressure to zero.
3. Remove the air tool or accessory.
4. Pull the safety drain valve ring to bleed excess pressure from tank. The pressure gauge for the tank should read 15-20 PSI.
5. Drain water from the tank by opening the drain valve on the bottom of the tank.
6. Close the drain valve when all the water has been released.
7. Store air compressor in its normal operating position in a cool protected area.

### **WARNING**

Water will condense in the air compressor tank. Water left in the tank can cause the tank to weaken and corrode, increasing the risk of tank rupture



# TROUBLESHOOTING

PROBLEM	CAUSE	ACTION
Pump motor will not start	<ol style="list-style-type: none"> <li>1. Low voltage.</li> <li>2. Open circuit in motor, switch or cord.</li> <li>3. Tank already pressurized.</li> <li>4. Thermal overload switch.</li> </ol>	<ol style="list-style-type: none"> <li>1. Check power line for proper voltage.</li> <li>2. Inspect all lead connections on motor, switch and cord for loose or open connections.</li> <li>3. Motor will not start if tank pressure is too high.</li> <li>4. Thermal overload switch has tripped, wait for motor to cool, then reset switch by pressing red button.</li> </ol>
Pump motor starts; but fuses blow or circuit breakers trip.	<ol style="list-style-type: none"> <li>1. Short circuit in line cord or plug.</li> <li>2. Short circuit in motor or loose connections.</li> <li>3. Incorrect fuses or circuit breakers in power line.</li> </ol>	<ol style="list-style-type: none"> <li>1. Inspect cord or plug for damaged insulation and shorted wires.</li> <li>2. Inspect all connections on motor for loose or shorted terminals or worn insulation.</li> <li>3. Install correct fuses or circuit breakers.</li> </ol>
Low pressure at the tool	<ol style="list-style-type: none"> <li>1. Air leaks in flexible hoses.</li> <li>2. Pressure gauge bad.</li> <li>3. Pressure regulator bad.</li> </ol>	<ol style="list-style-type: none"> <li>1. Check air hoses and all connections for leaks.</li> <li>2. Check pressure in line with known good gauge.</li> <li>3. Adjust pressure regulator, if no improvement inspect regulator for leaks or replacement.</li> </ol>
Low pressure at the tanks	<ol style="list-style-type: none"> <li>1. Air leaks in tanks or delivery pipes.</li> <li>2. Drain valve open.</li> <li>3. Safety valve releasing below 125 PSI.</li> <li>4. Air filter clogged.</li> <li>5. Gaskets leaking.</li> <li>6. Worn rings.</li> </ol>	<ol style="list-style-type: none"> <li>1. Check air tanks, pipes and all connections for leaks.</li> <li>2. Close drain valve.</li> <li>3. Replace safety valve.</li> <li>4. Inspect and clean air filter.</li> <li>5. Check gaskets on cylinder head assembly, repair or replace as needed.</li> <li>6. Inspect and replace pump piston rings.</li> </ol>
Compressor knocking	<ol style="list-style-type: none"> <li>1. Improper oil level.</li> <li>2. Air filter clogged.</li> <li>3. Piston assembly loose.</li> </ol>	<ol style="list-style-type: none"> <li>1. Check oil level and add oil.</li> <li>2. Inspect and clean air filter.</li> <li>3. Inspect and repair piston and connecting rod.</li> </ol>
Motor runs hot	<ol style="list-style-type: none"> <li>1. Cooling fins dirty.</li> <li>2. Air filter clogged.</li> </ol>	<ol style="list-style-type: none"> <li>1. Clean cylinder fins and motor area.</li> <li>2. Inspect and clean air filter.</li> </ol>

<b>PROBLEM</b>	<b>CAUSE</b>	<b>ACTION</b>
Motor runs hot	3. Compressor is exceeding its duty-cycle.	3. Do not allow the compressor to run over its recommended duty cycle.
Pressure relief valve stays open and motor won't stop running.	1. Faulty pressure switch, unit is trying to overpressure the tank. 2. Faulty pressure relief valve.	1. Turn compressor off, unplug from power supply, drain tank. DO NOT USE until switch is repaired or replaced. 2. Relief valve is relieving pressure too early, test pressure relief and repair or replace.
Air leaks from pressure switch	1. Faulty check valves.  2. faulty pressure switch.	1. Clean dirt or debris from rubber membrane of check valve after removing top nut. 2. Repair or replace pressure switch.
Air is dirty or has excessive moisture.	1. Tank is not drained.  2. Delivery pipes are dirty.	1. Open drain cocks on both tanks and make certain all condensation water is drained out. 2. Remove delivery pipes, clean out and replace.

# Model H3370 Pancake Air Compressor

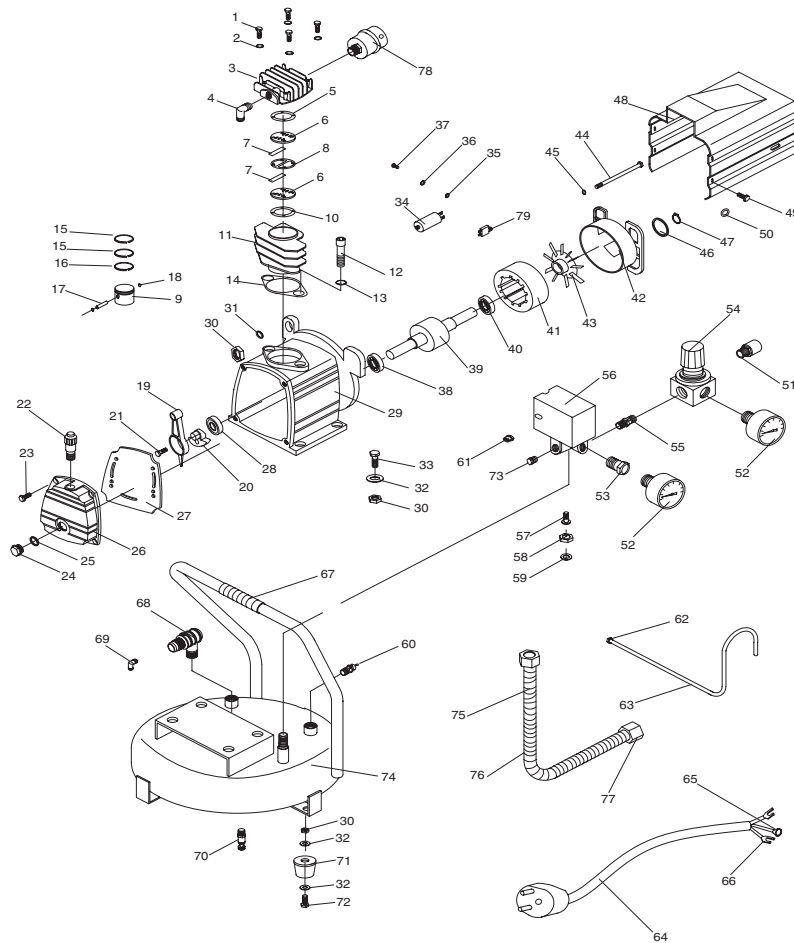

**Model 3370**

REF	PART #	DESCRIPTION
1	PB105M	HEX BOLT M6-1 X 55
2	PLW03M	LOCK WASHER 6MM
3	PH3370003	CYLINDER HEAD
4	PH3370004	90° ELBOW 3/8 MPT X 3/4-16 UNF
5	PH3370005	GASKET
6	PH3370006	VALVE PLATE
7	PH3370007	VALVE BLADE
8	PH3370008	GASKET-VALVE SPACER
9	PH3370009	PISTON
10	PH3370010	GASKET-CYLINDER
11	PH3370011	CYLINDER
12	PSB31M	CAP SCREW M8-1.25 X 25
13	PLW04M	LOCK WASHER 8MM
14	PH3370014	GASKET-CYLINDER TO CRANKCASE
15	PH3370015	COMPRESSION RING
16	PH3370016	OIL RING
17	PH3370017	PISTON PIN 12 X 37.5MM
18	PR49M	INT RETAINING RING 12MM
19	PH3370019	CONNECTING ROD
20	PH3370020	CRANK
21	PSB102M	CAP SCREW M8-1.25 X 22LH
22	PH3370022	OIL BREATHER 16MM
23	PB91M	HEX BOLT M6-1.0 X 18
24	PH3370024	OIL SIGHT GLASS G½
25	PH3370025	SEAL RING (M20 X 26 X3)
26	PH3370026	CRANKCASE COVER
27	PH3370027	GASKET
28	PH3370028	OIL SEAL 20 X 40 X 7
29	PH3370029	CRANKCASE
30	PN03M	HEX NUT M8-1.25
31	PW01M	FLAT WASHER 8MM
32	PW01M	FLAT WASHER 8MM
33	PB20M	HEX BOLT M8-1.25 X 35
34	PC120	CAPACITOR 120 MFD 250V
35	PW07M	FLAT WASHER 3MM
36	PLW09M	LOCK WASHER 3MM
37	PS12M	PHLP HD SCR M3-.5 X 6
38	P6202	FRONT BEARING 6202
39	PH3370039	ROTATOR 67MM
40	P6202	REAR BEARING 6202

**Model 3370**

REF	PART #	DESCRIPTION
41	PH3370041	STATOR 115V/60HZ
42	PH3370042	FAN COVER
43	PH3370043	MOTOR FAN
44	PB106M	HEX BOLT M5-0.8 X 115
45	PLW01M	LOCK WASHER 5MM
46	PH3370046	GASKET
47	PR02M	EXT RETAINING RING 14MM
48	PH3370048	MOTOR COVER
49	PFB05	FLANGE BOLT M5-.8 X 15
50	PW03M	FLAT WASHER 6MM
51	PH3370051	QUICK COUPLER
52	PH3370052	PRESSURE GAUGE
53	PH3370053	HEX BUSHING OD ¼ X ID ⅛ MPT
54	PH3370054	REGULATOR
55	PH3370055	NIPPLE NPT ¼ X 40
56	PH3370056	PRESSURE SWITCH-LF10
57	PH3370057	STEM ADAPTER ¼ MPT
58	PH3370058	FLARE CONNECTOR ⅜ FPT
59	PH3370059	PLASTIC GASKET 6MM
60	PH3370060	SAFETY VALVE ¼ NB 130 PSI
61	PH3370061	BUTTON
62	PH3370062	FLARE CONNECTOR 10MM
63	PH3370063	RELIEF COPPER PIPE 6 X 590
64	PH3370064	POWER CORD 14# X 2M
65	PH3370065	RING TERMINAL #10
66	PH3370066	FORK TERMINAL #10
67	PH3370067	GRIP COVER 25MM
68	PH3370068	CHECK VALVE
69	PH3370069	90° ELBOW ⅛ MPT X ⅛ MPT
70	PH3370070	DRAIN VALVE 14MM
71	PH3370071	RUBBER FOOT
72	PB09M	HEX BOLT M8-1.25 X 20
73	PH3370073	PLUG ¼ MPT
74	PH3370074	TANK 4 GALLON PANCAKE
75	PH3370075	DISCHARGE PIPE (M12 X 360)
76	PH3370076	COOLER M12 X 380
77	PLN05	LOCK NUT 3/4-16
78	PH3370078	AIR INTAKE FILTER
79	PH3370079	THERMAL OVERLOAD PROTECTOR

# Model H3371 Hot Dog Air Compressor

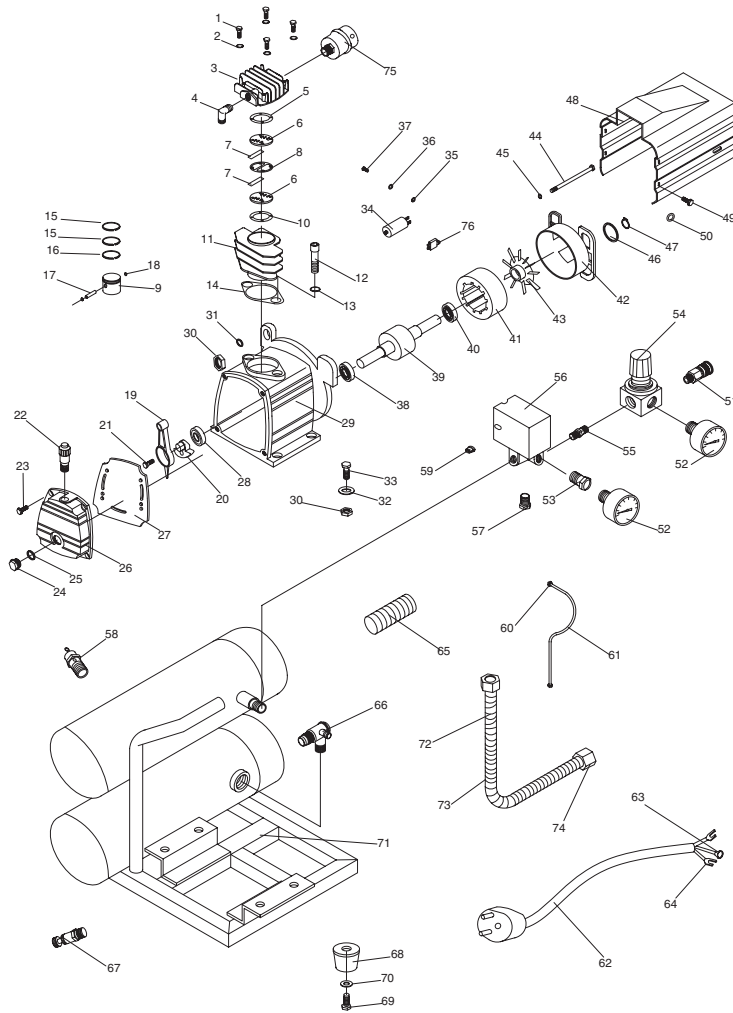

**Model 3371**

REF	PART #	DESCRIPTION
1	PB105M	HEX BOLT M6-1 X 55
2	PLW03M	LOCK WASHER 6MM
3	PH3370003	CYLINDER HEAD
4	PH3370004	90° ELBOW 3/8 MPT X 3/4-16 UNF
5	PH3370005	GASKET
6	PH3370006	VALVE PATCH
7	PH3370007	VALVE PLANK SPACER
8	PH3370008	GASKET
9	PH3370009	PISTON
10	PH3370010	GASKET-CYLINDER
11	PH3370011	CYLINDER
12	PSB31M	CAP SCREW M8-1.25 X 25
13	PLW04M	LOCK WASHER 8MM
14	PH3370014	GASKET-CYLINDER TO CRANKCASE
15	PH3370015	COMPRESSION RING
16	PH3370016	OIL RING
17	PH3370017	PISTON PIN 12 X 37.5MM
18	PR49M	INT RETAINING RING 12MM
19	PH3370019	CONNECTING ROD
20	PH3370020	CRANK
21	PSB102M	CAP SCREW M8-1.25 X 22LH
22	PH3370022	OIL BREATHER 16MM
23	PB91M	HEX BOLT M6-1.0 X 18
24	PH3370024	OIL SIGHT GLASS G1/2
25	PH3370025	SEAL RING (M20 X 26 X 3)
26	PH3370026	CRANKCASE COVER
27	PH3370027	GASKET
28	PH3370028	OIL SEAL 20 X 40 X 7
29	PH3370029	CRANKCASE
30	PN03M	HEX NUT M8-1.25
31	PW01M	FLAT WASHER 8MM
32	PW01M	FLAT WASHER 8MM
33	PB20M	HEX BOLT M8-1.25 X 35
34	PC120	CAPACITOR 120 MFD 250V
35	PW07M	FLAT WASHER 3MM
36	PLW09M	LOCK WASHER 3MM
37	PS12M	PHLP HD SCR M3-.5 X 6
38	P6202	FRONT BEARING 6202
39	PH3370039	ROTATOR 67MM

**Model 3371**

REF	PART #	DESCRIPTION
40	P6202	REAR BEARING 6202
41	PH3370041	STATOR 115V/ 60HZ
42	PH3370042	FAN COVER
43	PH3370043	MOTOR FAN
44	PB106M	HEX BOLT M5-0.8 X 115
45	PLW01M	LOCK WASHER 5MM
46	PH3370046	GASKET
47	PR02M	EXT RETAINING RING 14MM
48	PH3370048	MOTOR COVER
49	PFB05	FIANGE BOLT M5-.8 X 15
50	PW03M	FLAT WASHER 6MM
51	PH3370051	QUICK COUPLER
52	PH3370052	PRESSURE GAUGE
53	PH3370053	HEX BUSHING OD ¼ X ID ⅛ MPT
54	PH3370054	REGULATOR
55	PH3370055	NIPPLE NPT ¼ X 40
56	PH3370056	PRESSURE SWITCH-LF10
57	PH3370057	STEM ADAPTER ¼ MPT
58	PH3370060	SAFETY VALVE ¼ NB 130 PSI
59	PH3370061	BUTTON
60	PH3370062	FLARE CONNECTOR ID 10MM
61	PH3370063	COPPER PIPE 6MM
62	PH3370064	POWER CORD 14# X 2M
63	PH3370065	RING TERMINAL #10
64	PH3370066	FORK TERMINAL #10
65	PH3371065	GRIP COVER 25MM
66	PH3371066	CHECK VALVE
67	PH3370070	DRAIN VALVE 14MM
68	PH3371068	CUSHION FOOT
69	PHTEK18	TAP SCREW #10 X 5/8
70	PW04M	FLAT WASHER 10MM
71	PH3371071	TANK TWO 2 GALLON HOT DOG
72	PH3370075	DISCHARGE PIPE (M12 X 360)
73	PH3370076	COOLER M12 X 380
74	PLN05	LOCK NUT 3/4-16
75	PH3370078	AIR INTAKE FILTER
76	PH3370079	THERMAL OVERLOAD PROTECTOR



# NOTES

---

---

# WARRANTY AND RETURNS

---

Grizzly Industrial, Inc. warrants every product it sells for a period of **1 year** to the original purchaser from the date of purchase. This warranty does not apply to defects due directly or indirectly to misuse, abuse, negligence, accidents, repairs or alterations or lack of maintenance. This is Grizzly's sole written warranty and any and all warranties that may be implied by law, including any merchantability or fitness, for any particular purpose, are hereby limited to the duration of this written warranty. We do not warrant or represent that the merchandise complies with the provisions of any law or acts unless the manufacturer so warrants. In no event shall Grizzly's liability under this warranty exceed the purchase price paid for the product and any legal actions brought against Grizzly shall be tried in the State of Washington, County of Whatcom.

We shall in no event be liable for death, injuries to persons or property or for incidental, contingent, special, or consequential damages arising from the use of our products.

To take advantage of this warranty, contact us by mail or phone and give us all the details. We will then issue you a "Return Authorization Number," which must be clearly posted on the outside as well as the inside of the carton. We will not accept any item back without this number. Proof of purchase must accompany the merchandise.

The manufacturers reserve the right to change specifications at any time because they constantly strive to achieve better quality equipment. We make every effort to ensure that our products meet high quality and durability standards and we hope you never need to use this warranty.

Please feel free to write or call us if you have any questions about the machine or the manual.

Grizzly Industrial, Inc.  
1203 Lycoming Mall Circle  
Muncy, PA 17756  
Phone: (570) 546-9663  
Fax: (800) 438-5901

E-Mail:  
techsupport@grizzly.com

Web Site: <http://www.grizzly.com>

Thank you again for your business and continued support. We hope to serve you again soon!

# WARRANTY CARD

Name \_\_\_\_\_  
Street \_\_\_\_\_  
City \_\_\_\_\_ State \_\_\_\_\_ Zip \_\_\_\_\_  
Phone Number \_\_\_\_\_ E-Mail \_\_\_\_\_ FAX \_\_\_\_\_  
Model # \_\_\_\_\_ Serial# \_\_\_\_\_ Order # \_\_\_\_\_

The following information is given on a voluntary basis. It will be used for marketing purposes to help us develop better products and services. Of course, all information is strictly confidential.

- How did you learn about us?  
 Advertisement  Friend  
 Catalog  Card Deck  
 World Wide Web  
 Other \_\_\_\_\_
- What is your annual household income?  
 \$20,000-\$29,999  \$60,000-\$69,999  
 \$30,000-\$39,999  \$70,000-\$79,999  
 \$40,000-\$49,999  \$80,000-\$89,999  
 \$50,000-\$59,999  \$90,000 +
- What is your age group?  
 20-29  50-59  
 30-39  60-69  
 40-49  70 +
- How long have you been a woodworker?  
 0 - 2 Years  8 - 20 Years  
 2 - 8 Years  20+ Years
- How would you rank your woodworking skills?  
 Simple  Advanced  
 Intermediate  Master Craftsman
- What stationary woodworking tools do you own? Check all that apply.  
 Air Compressor  Panel Saw  
 Band Saw  Planer  
 Drill Press  Power Feeder  
 Drum Sander  Radial Arm Saw  
 Dust Collector  Shaper  
 Spindle Sander  Jointer  
 Table Saw  Lathe  
 Mortiser  Wide Belt Sander  
 Horiz.Boring Machine  
 Vacuum Veneer Press  
 Other \_\_\_\_\_
- How many of your woodworking machines are Grizzly? \_\_\_\_\_
- Which benchtop tools do you own? Check all that apply.  
 1"x42" Belt Sander  6" - 8" Grinder  
 5" - 8" Drill Press  Mini Lathe  
 8" Table Saw  8" - 10" Bandsaw  
 Scroll Saw  Disc/Belt Sander  
 Spindle/Belt Sander  Mini Jointer  
 10"-12" Thickness Planer  
 Other \_\_\_\_\_
- How many of the machines checked above are Grizzly? \_\_\_\_\_
- Which portable/hand held power tools do you own? Check all that apply.  
 Belt Sander  Orbital Sander  
 Biscuit Joiner  Palm Sander  
 Circular Saw  Portable Planer  
 Detail Sander  Saber Saw  
 Drill/Driver  Reciprocating Saw  
 Miter Saw  Router  
 Other \_\_\_\_\_
- What machines/supplies would you like Grizzly Industrial to carry?  
\_\_\_\_\_  
\_\_\_\_\_  
\_\_\_\_\_
- What new accessories would you like Grizzly Industrial to carry?  
\_\_\_\_\_  
\_\_\_\_\_  
\_\_\_\_\_
- What other companies do you purchase your tools and supplies from?  
\_\_\_\_\_  
\_\_\_\_\_  
\_\_\_\_\_
- Do you think your purchase represents good value?  
 Yes  No
- Would you recommend Grizzly to a friend?  
 Yes  No
- Would you allow us to use your name as a reference for Grizzly customers in your area? **Note: We never use names more than three times.**  
 Yes  No
- Comments: \_\_\_\_\_  
\_\_\_\_\_  
\_\_\_\_\_

Send a Grizzly Catalog to a friend:

Name _____
Street _____
City _____ State _____ Zip _____

FOLD ALONG DOTTED LINE

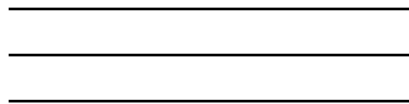

Place  
Stamp  
Here



GRIZZLY INDUSTRIAL, INC.  
P.O. BOX 2069  
BELLINGHAM, WA 98227-2069



TAPE ALONG EDGES--PLEASE DO NOT NAIL